

48" I.D. MANHOLE - MAX. TWO 4" DROPS
 60" I.D. MANHOLE - MAX. FOUR 4" DROPS

ESS BROS. MCI-309, OR NEENAH CASTING NO.1642, W/2 CONCEALED PICKHOLES AND THE WORDS "SANITARY SEWER" STAMPED ON THE COVER. OR APPROVED EQUAL

MIN, 2 CONCRETE ADJUSTING RINGS. MAX OF 1' OF RINGS. THE CONTRACTOR SHALL USE A 6" ADJUSTING RING IF THE REQUIRED ADJUSTMENT IS BETWEEN 8" AND 1'.

SERVICE INTO MANHOLE

1. COREDRILL 4" DIA. IN MANHOLE AND INSERT KOR-N-TEE
2. CONNECT SERVICE AT MANHOLE AS PER DETAIL
3. MINIMUM 1 PIPE LENGTH OF D.I.P. OUT OF MANHOLE
4. SECURE 4" PVC DROP PIPE TO MANHOLE WALL WITH STAINLESS STEEL BAND'S.
5. ALL BENDS AND SECTIONS OF PVC DROP SHALL HAVE SOLVENT JOINTS.
6. POUR GROUTED BENCH FOR 4" SERVICE DROP ON BENCH OF MANHOLE.

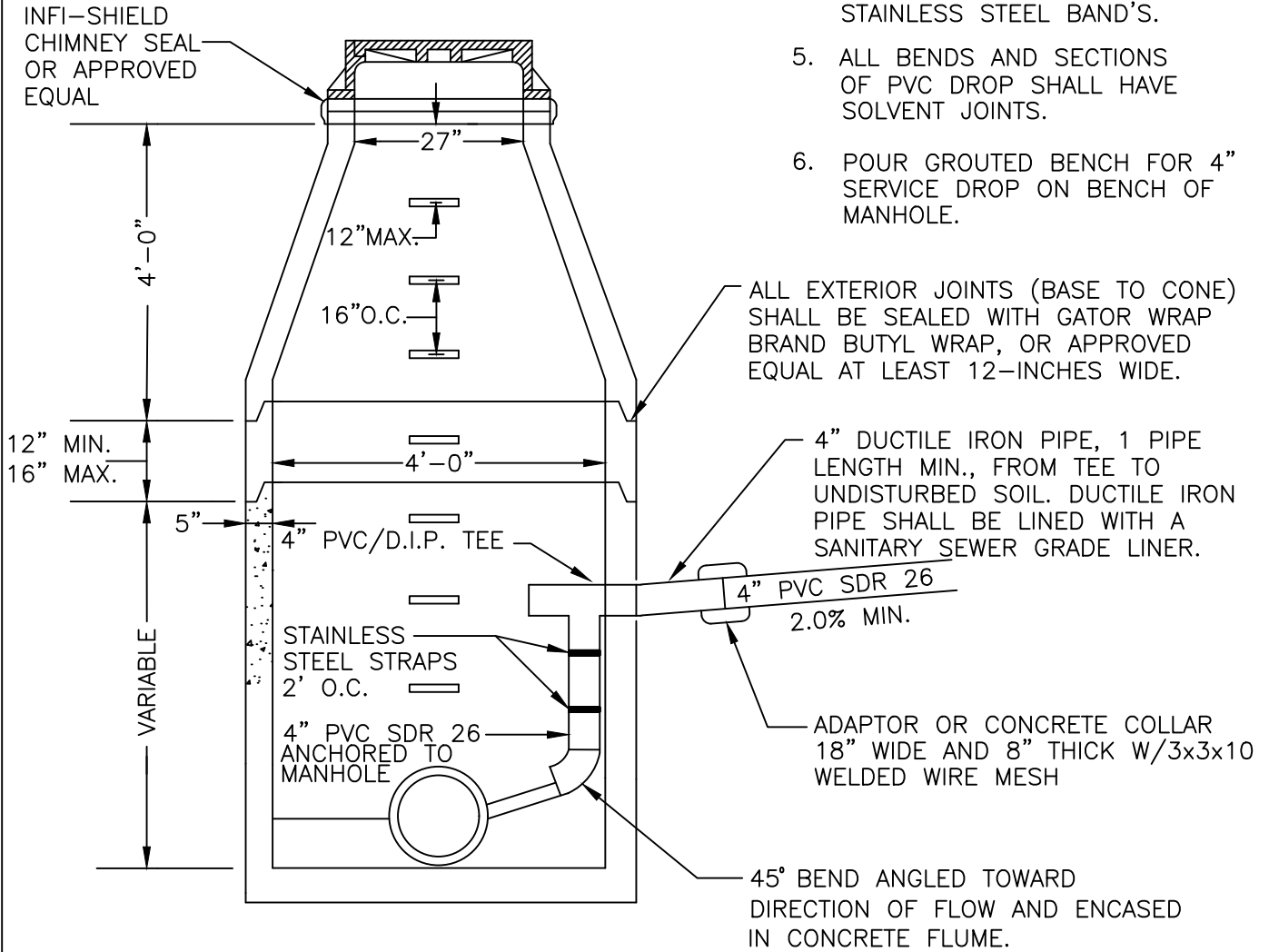

SEE LV-SS-1 FOR SANITARY SEWER STANDARD MANHOLE



SANITARY SEWER
 MANHOLE WITH
 INSIDE SERVICE DROP

PLATE NO. LV-SS-10

DATE 01/2020